

A-1

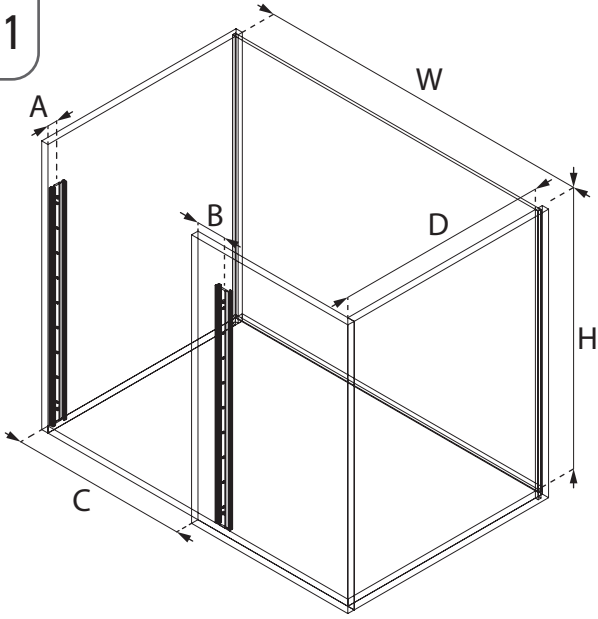

C	400	450	500	600
A	26	26	26	41
B	76	76	71	86
W	Min 864	Min 864	Min 964	Min 964
D	Min 460	Min 510	Min 520	Min 520
H	Min 600	Min 600	Min 600	Min 600

A-4

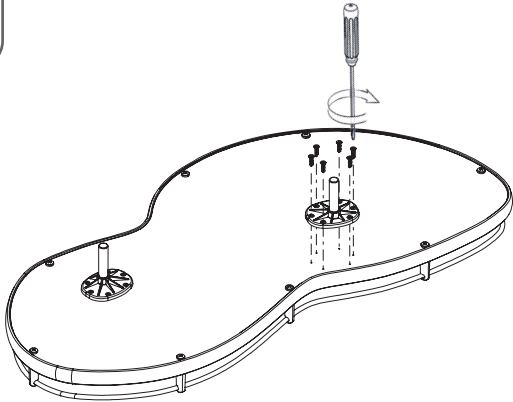

A-2

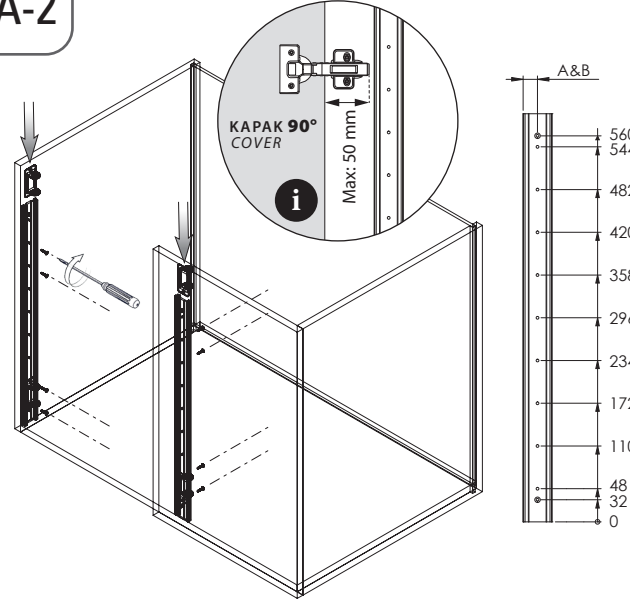

A-3

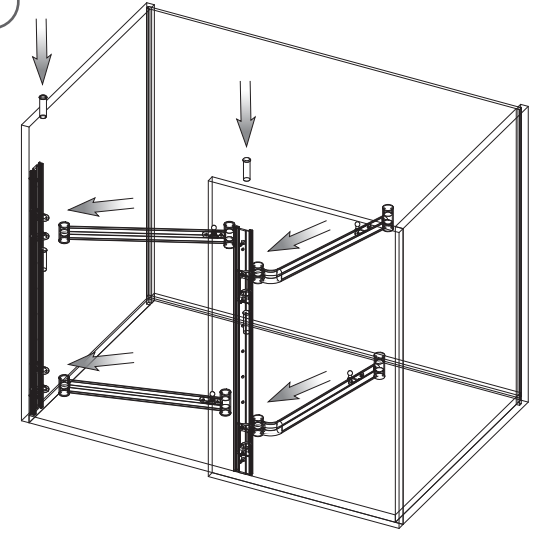

A-5

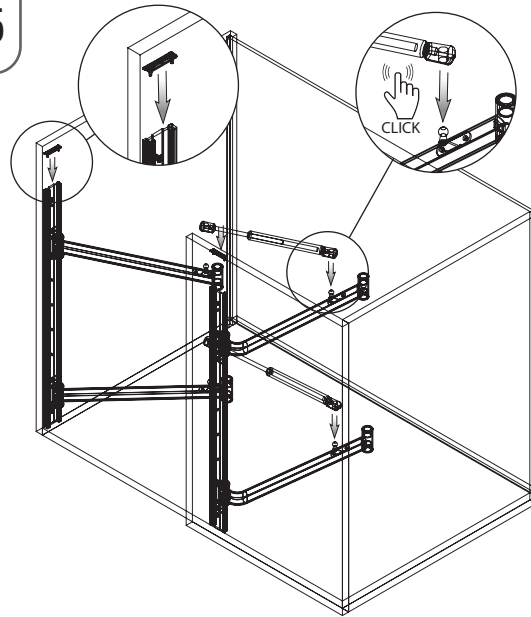

A-6

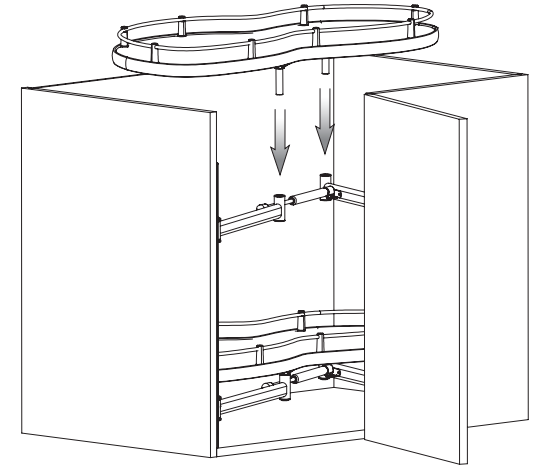

A-1

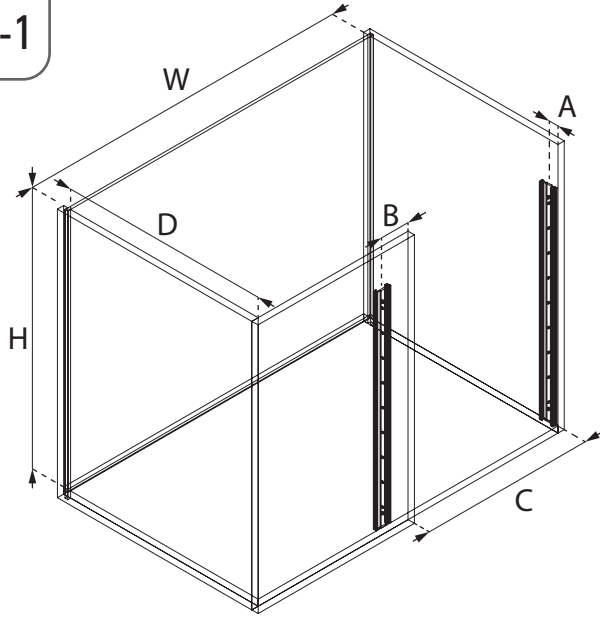

C	400	450	500	600
A	26	26	26	41
B	76	76	71	86
W	Min 864	Min 864	Min 964	Min 964
D	Min 460	Min 510	Min 520	Min 520
H	Min 600	Min 600	Min 600	Min 600

A-4

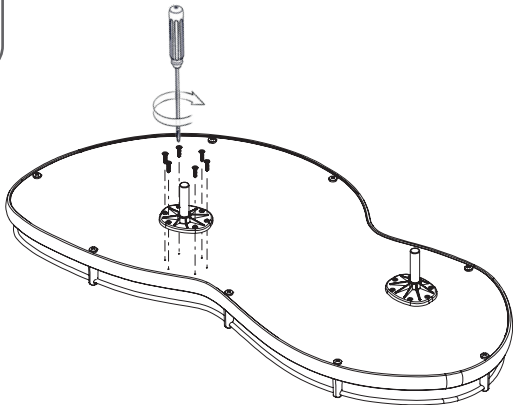

A-2

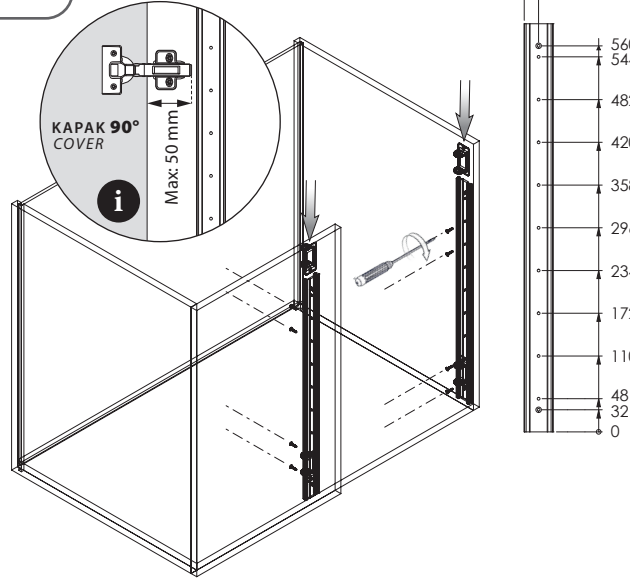

A-5

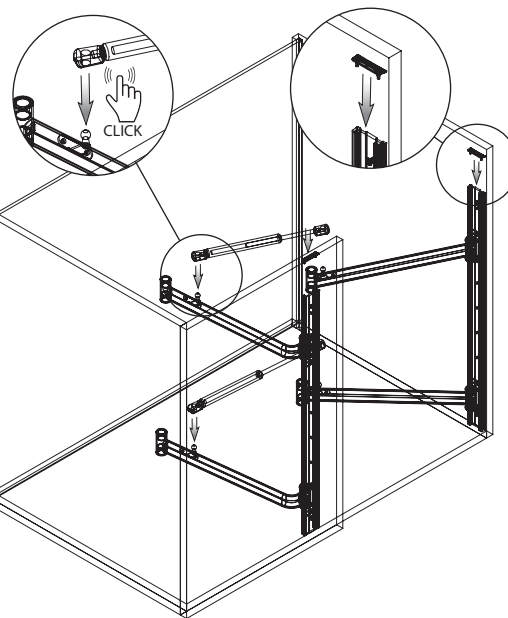

A-3

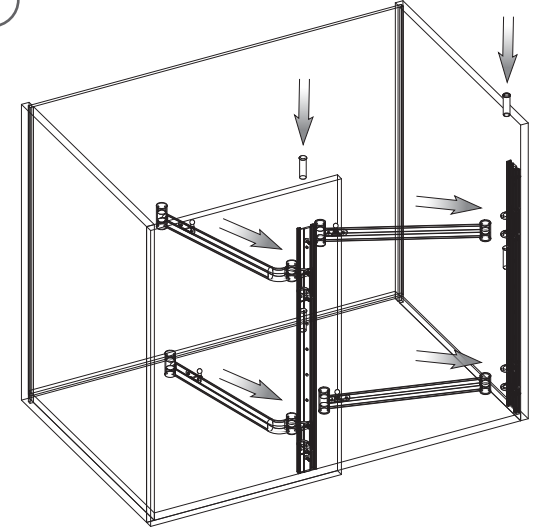

A-6

